

Trench gate field-stop 650 V, 80 A high speed HB series IGBT

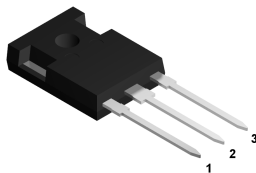

TO-247 long leads

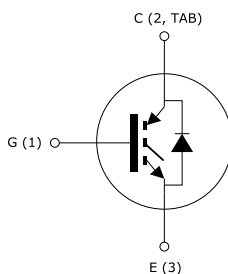

Product status link

[STGWA80H65DFB](#)

Product summary

Order code	STGWA80H65DFB
Marking	GWA80H65DFB
Package	TO-247 long leads
Packing	Tube

Features

- Maximum junction temperature: $T_J = 175\text{ }^\circ\text{C}$
- High speed switching series
- Minimized tail current
- Low saturation voltage: $V_{CE(sat)} = 1.6\text{ V (typ.) @ } I_C = 80\text{ A}$
- Tight parameter distribution
- Safe paralleling
- Positive $V_{CE(sat)}$ temperature coefficient
- Low thermal resistance
- Very fast soft recovery antiparallel diode

Applications

- Photovoltaic inverters
- High frequency converters

Description

This device is an IGBT developed using an advanced proprietary trench gate field-stop structure. The device is part of the new HB series of IGBTs, which represents an optimum compromise between conduction and switching loss to maximize the efficiency of any frequency converter. Furthermore, the slightly positive $V_{CE(sat)}$ temperature coefficient and very tight parameter distribution result in safer paralleling operation.

1 Electrical ratings

Table 1. Absolute maximum ratings

Symbol	Parameter	Value	Unit
V_{CES}	Collector-emitter voltage ($V_{GE} = 0$)	650	V
I_C	Continuous collector current at $T_C = 25\text{ °C}$	120 ⁽¹⁾	A
	Continuous collector current at $T_C = 100\text{ °C}$	80	
I_{CP} ⁽²⁾	Pulsed collector current ($t_p \leq 1\ \mu\text{s}$, $T_J < 175\text{ °C}$)	300	A
V_{GE}	Gate-emitter voltage	± 20	V
	Transient gate-emitter voltage	± 30	V
I_F	Continuous forward current at $T_C = 25\text{ °C}$	120 ⁽¹⁾	A
	Continuous forward current at $T_C = 100\text{ °C}$	80	
I_{FP} ⁽²⁾	Pulsed forward current ($t_p \leq 1\ \mu\text{s}$, $T_J < 175\text{ °C}$)	300	A
P_{TOT}	Total power dissipation at $T_C = 25\text{ °C}$	470	W
T_{STG}	Storage temperature range	- 55 to 150	°C
T_J	Operating junction temperature range	- 55 to 175	

1. Current level is limited by bond wires
2. Defined by design, not subject to production test.

Table 2. Thermal data

Symbol	Parameter	Value	Unit
R_{thJC}	Thermal resistance junction-case IGBT	0.32	°C/W
R_{thJC}	Thermal resistance junction-case diode	0.66	
R_{thJA}	Thermal resistance junction-ambient	50	

2 Electrical characteristics

$T_C = 25\text{ °C}$ unless otherwise specified

Table 3. Static characteristics

Symbol	Parameter	Test conditions	Min.	Typ.	Max.	Unit
$V_{(BR)CES}$	Collector-emitter breakdown voltage	$V_{GE} = 0\text{ V}, I_C = 2\text{ mA}$	650			V
$V_{CE(sat)}$	Collector-emitter saturation voltage	$V_{GE} = 15\text{ V}, I_C = 80\text{ A}$		1.6	2	V
		$V_{GE} = 15\text{ V}, I_C = 80\text{ A}, T_J = 125\text{ °C}$		1.8		
		$V_{GE} = 15\text{ V}, I_C = 80\text{ A}, T_J = 175\text{ °C}$		1.9		
V_F	Forward on-voltage	$I_F = 80\text{ A}$		1.9	2.3	V
		$I_F = 80\text{ A}, T_J = 125\text{ °C}$		1.6		
		$I_F = 80\text{ A}, T_J = 175\text{ °C}$		1.5		
$V_{GE(th)}$	Gate threshold voltage	$V_{CE} = V_{GE}, I_C = 1\text{ mA}$	5	6	7	V
I_{CES}	Collector cut-off current	$V_{GE} = 0\text{ V}, V_{CE} = 650\text{ V}$			100	μA
I_{GES}	Gate-emitter leakage current	$V_{CE} = 0\text{ V}, V_{GE} = \pm 20\text{ V}$			± 250	nA

Table 4. Dynamic characteristics

Symbol	Parameter	Test conditions	Min.	Typ.	Max.	Unit
C_{ies}	Input capacitance	$V_{CE} = 25\text{ V}, f = 1\text{ MHz}, V_{GE} = 0\text{ V}$	-	10524	-	pF
C_{oes}	Output capacitance		-	385	-	
C_{res}	Reverse transfer capacitance		-	215	-	
Q_g	Total gate charge	$V_{CC} = 520\text{ V}, I_C = 80\text{ A}, V_{GE} = 15\text{ V}$ (see Figure 28. Gate charge test circuit)	-	414	-	nC
Q_{ge}	Gate-emitter charge		-	78	-	
Q_{gc}	Gate-collector charge		-	170	-	

Table 5. IGBT switching characteristics (inductive load)

Symbol	Parameter	Test conditions	Min.	Typ.	Max.	Unit	
$t_{d(on)}$	Turn-on delay time	$V_{CE} = 400\text{ V}$, $I_C = 80\text{ A}$, $V_{GE} = 15\text{ V}$, $R_G = 10\ \Omega$ (see Figure 27. Test circuit for inductive load switching)		84	-	ns	
t_r	Current rise time			52	-		
$(di/dt)_{on}$	Turn-on current slope			1270	-	A/ μs	
$t_{d(off)}$	Turn-off-delay time		$V_{CE} = 400\text{ V}$, $I_C = 80\text{ A}$, $V_{GE} = 15\text{ V}$, $R_G = 10\ \Omega$, $T_J = 175\text{ }^\circ\text{C}$ (see Figure 27. Test circuit for inductive load switching)		280	-	ns
t_f	Current fall time				31	-	
$E_{on}^{(1)}$	Turn-on switching energy				2.1	-	mJ
$E_{off}^{(2)}$	Turn-off switching energy				1.5	-	
E_{ts}	Total switching energy				3.6	-	
$t_{d(on)}$	Turn-on delay time			$V_{CE} = 400\text{ V}$, $I_C = 80\text{ A}$, $V_{GE} = 15\text{ V}$, $R_G = 10\ \Omega$, $T_J = 175\text{ }^\circ\text{C}$ (see Figure 27. Test circuit for inductive load switching)		77	-
t_r	Current rise time				51	-	
$(di/dt)_{on}$	Turn-on current slope				1270	-	A/ μs
$t_{d(off)}$	Turn-off-delay time	$V_{CE} = 400\text{ V}$, $I_C = 80\text{ A}$, $V_{GE} = 15\text{ V}$, $R_G = 10\ \Omega$, $T_J = 175\text{ }^\circ\text{C}$ (see Figure 27. Test circuit for inductive load switching)				328	-
t_f	Current fall time				30	-	
$E_{on}^{(1)}$	Turn-on switching energy				4.4	-	mJ
$E_{off}^{(2)}$	Turn-off switching energy				2.1	-	
E_{ts}	Total switching energy				6.5	-	

1. Including the reverse recovery of the diode.
2. Including the tail of the collector current.

Table 6. Diode switching characteristics (inductive load)

Symbol	Parameter	Test conditions	Min.	Typ.	Max.	Unit	
t_{rr}	Reverse recovery time	$I_F = 80\text{ A}$, $V_R = 400\text{ V}$, $V_{GE} = 15\text{ V}$ di/ dt = 100 A/ μs (see Figure 27. Test circuit for inductive load switching)	-	85	-	ns	
Q_{rr}	Reverse recovery charge			-	1105	-	nC
I_{rrm}	Reverse recovery current			-	26	-	A
di_{rr}/dt	Peak rate of fall of reverse recovery current during t_b			-	722	-	A/ μs
E_{rr}	Reverse recovery energy			-	267	-	μJ
t_{rr}	Reverse recovery time	$I_F = 80\text{ A}$, $V_R = 400\text{ V}$, $V_{GE} = 15\text{ V}$, $T_J = 175\text{ }^\circ\text{C}$ di/dt = 100 A/ μs (see Figure 27. Test circuit for inductive load switching)	-	149	-	ns	
Q_{rr}	Reverse recovery charge			-	4920	-	nC
I_{rrm}	Reverse recovery current			-	66	-	A
di_{rr}/dt	Peak rate of fall of reverse recovery current during t_b			-	546	-	A/ μs
E_{rr}	Reverse recovery energy			-	1172	-	μJ

2.1 Electrical characteristics (curves)

Figure 1. Power dissipation vs case temperature

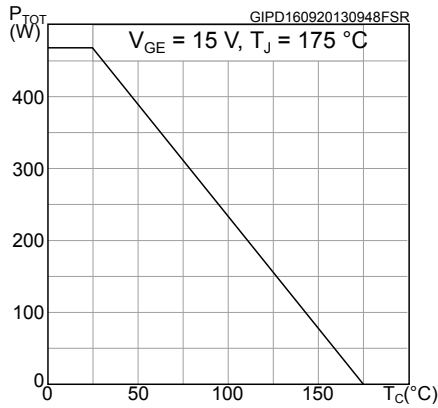

Figure 2. Collector current vs case temperature

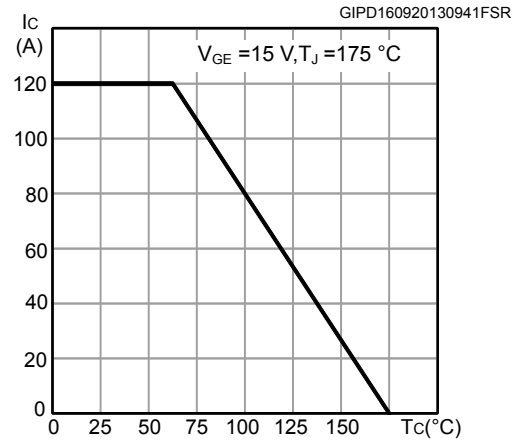

Figure 3. Output characteristics (T_J = 25 °C)

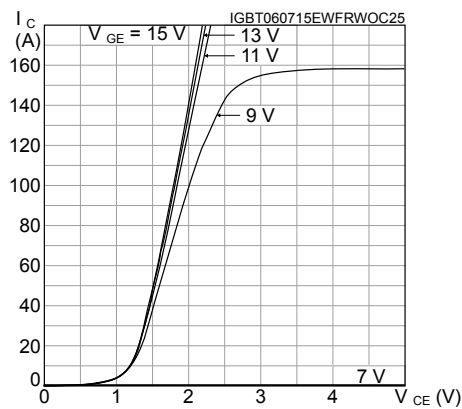

Figure 4. Output characteristics (T_J = 175 °C)

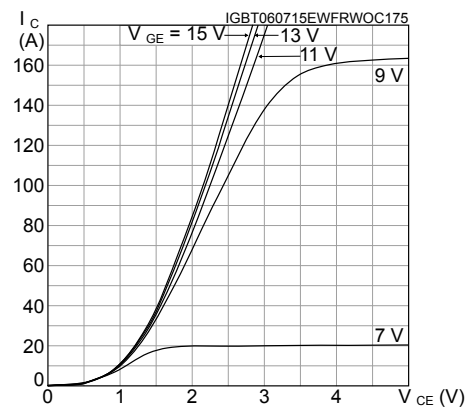

Figure 5. V_{CE(sat)} vs junction temperature

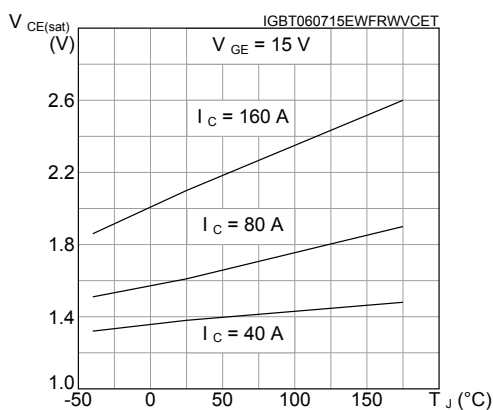

Figure 6. V_{CE(sat)} vs collector current

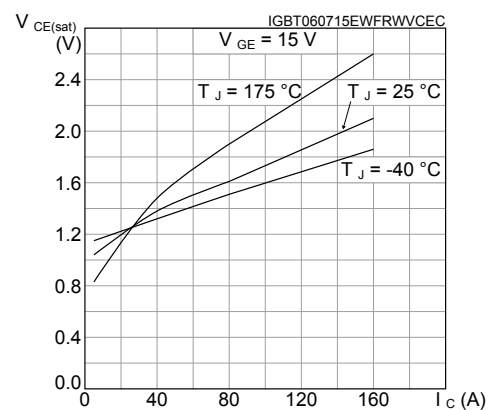

Figure 7. Collector current vs switching frequency

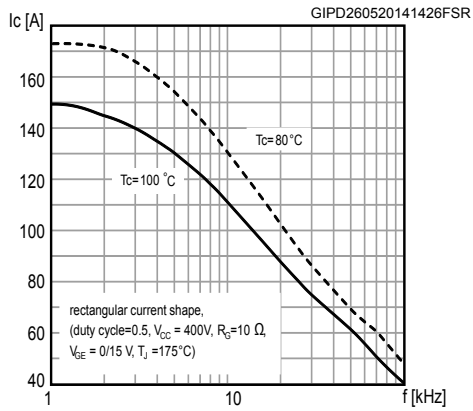

Figure 8. Forward bias safe operating area

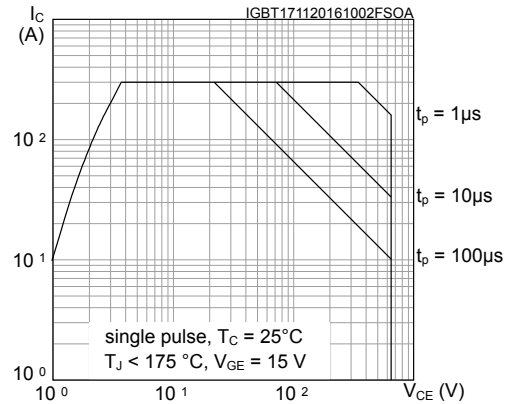

Figure 9. Transfer characteristics

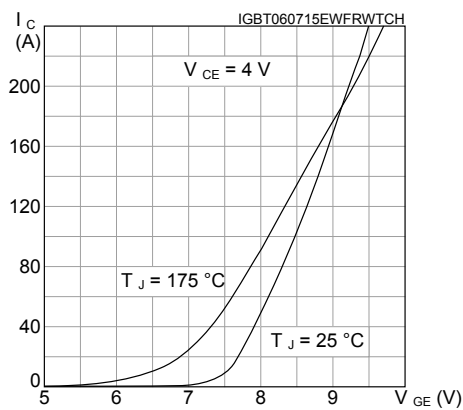

Figure 10. Diode Vf vs forward current

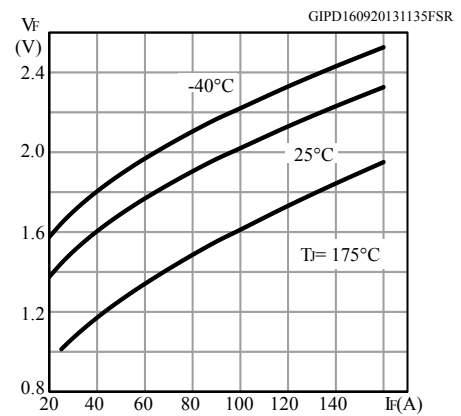

Figure 11. Normalized Vge(th) vs junction temperature

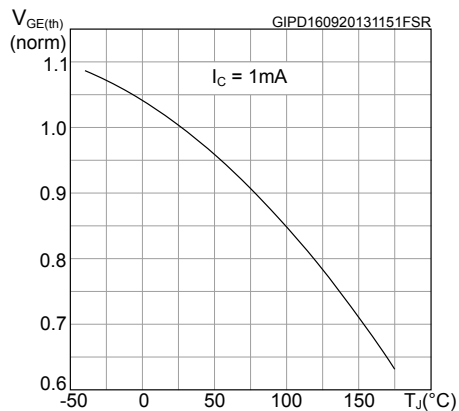

Figure 12. Normalized Vbr(CES) vs junction temperature

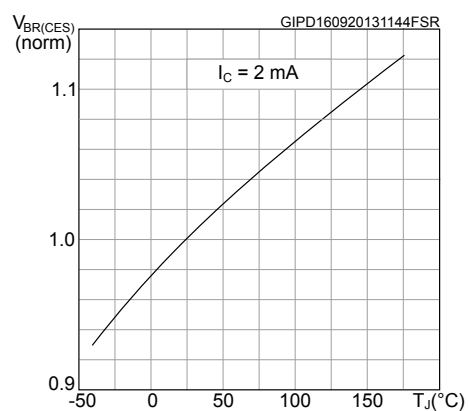

Figure 13. Capacitance variations

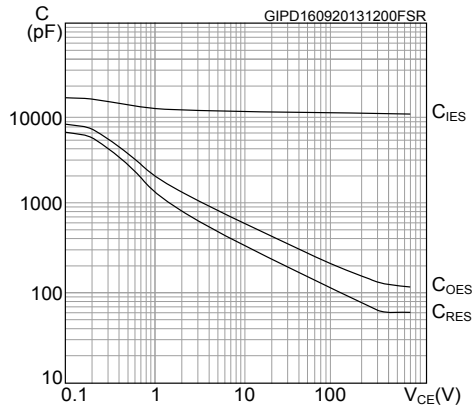

Figure 14. Gate charge vs gate-emitter voltage

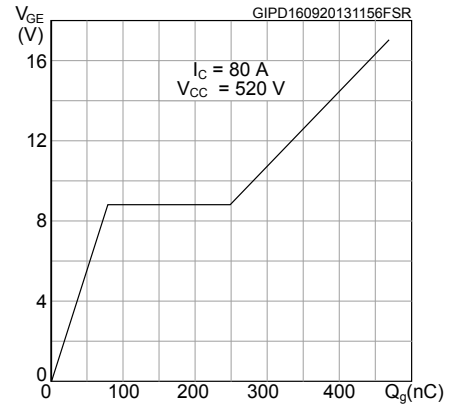

Figure 15. Switching energy vs collector current

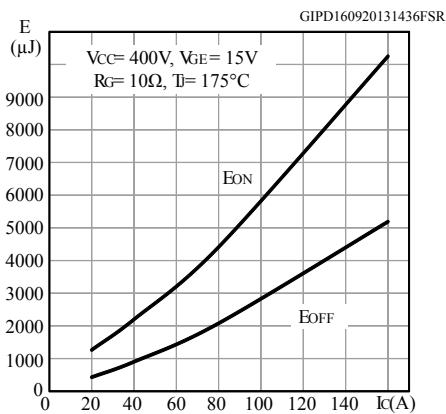

Figure 16. Switching energy vs gate resistance

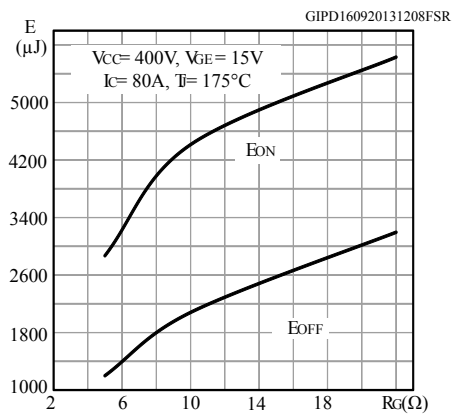

Figure 17. Switching energy vs temperature

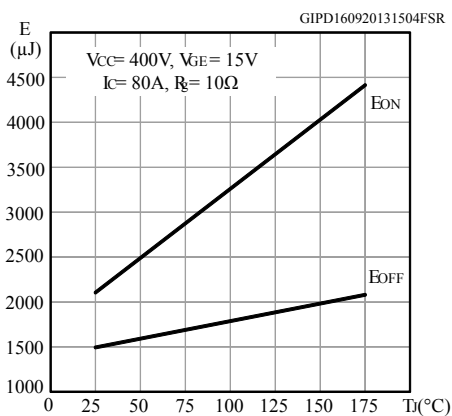

Figure 18. Switching energy vs collector emitter voltage

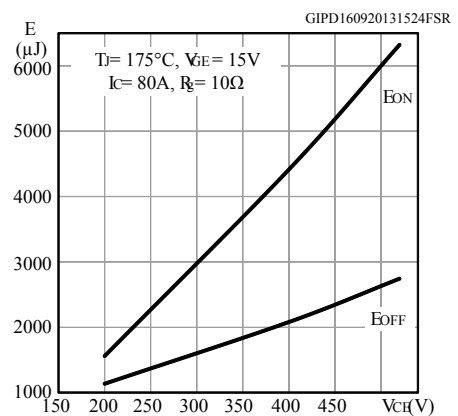

Figure 19. Switching times vs collector current

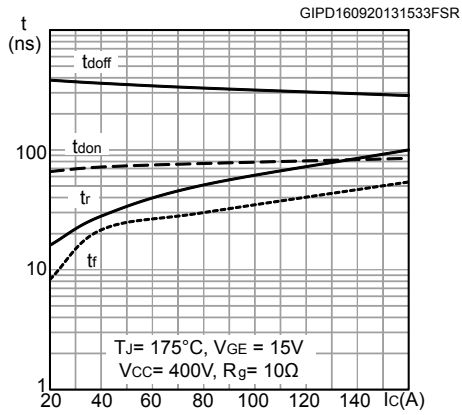

Figure 20. Switching times vs gate resistance

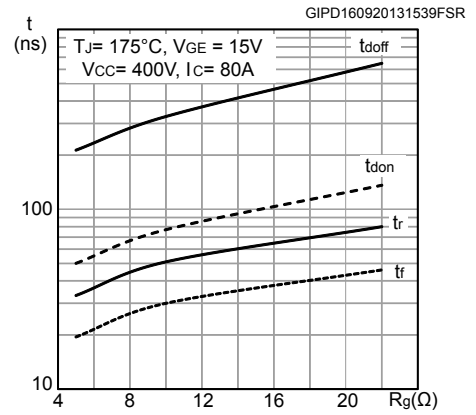

Figure 21. Reverse recovery current vs diode current slope

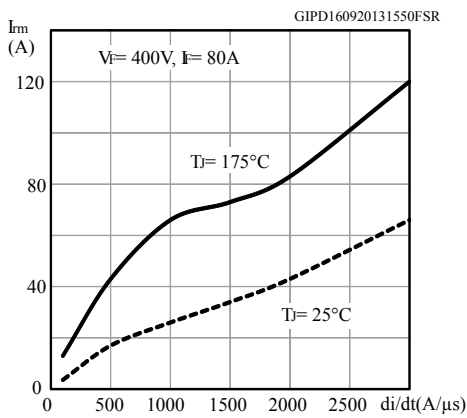

Figure 22. Reverse recovery time vs diode current slope

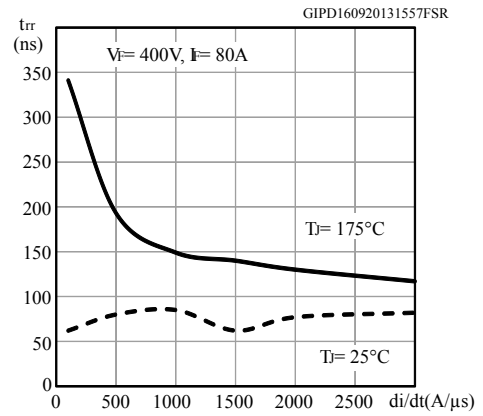

Figure 23. Reverse recovery charge vs diode current slope

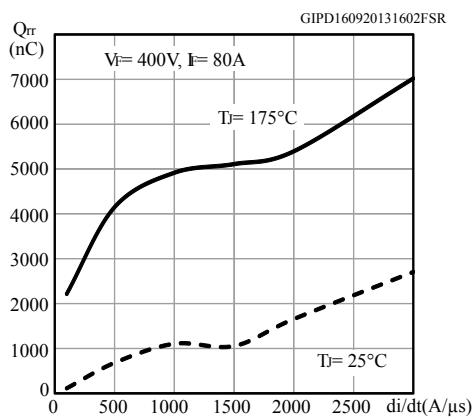

Figure 24. Reverse recovery energy vs diode current slope

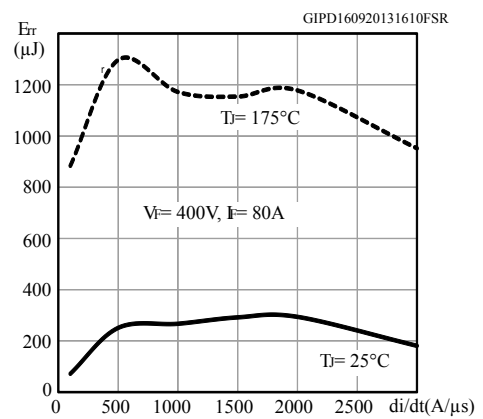

Figure 25. Thermal impedance for IGBT

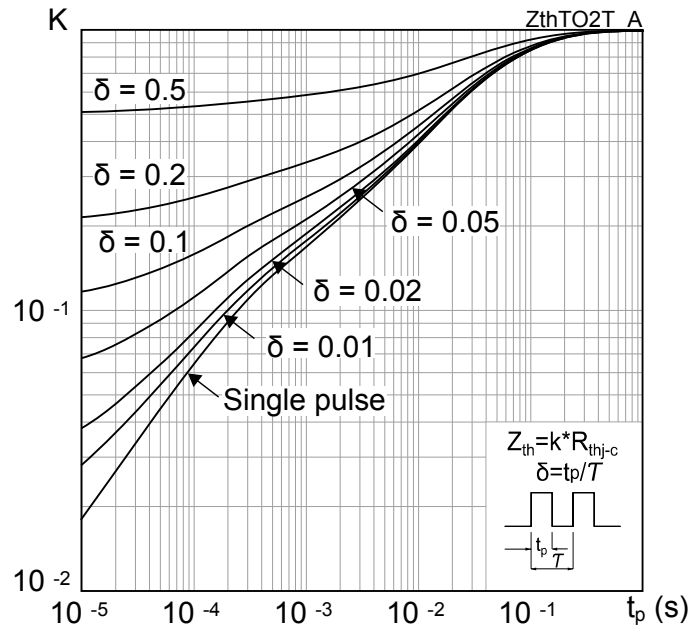
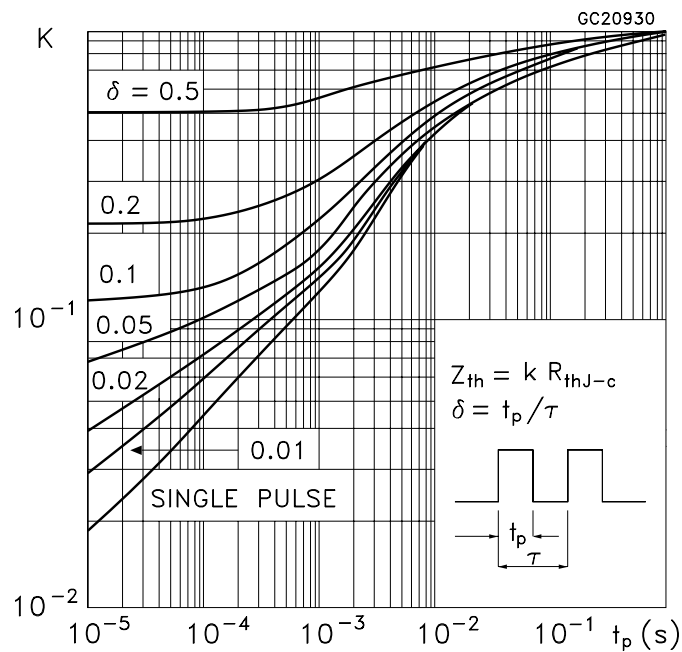
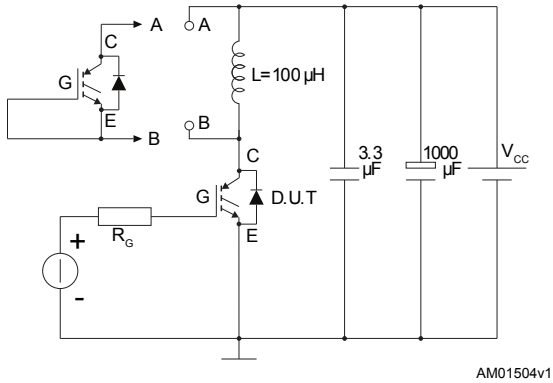
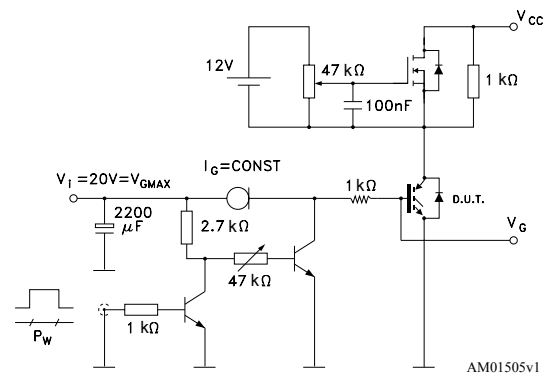
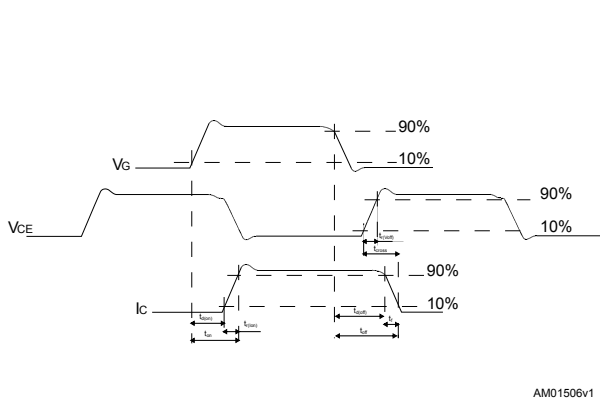
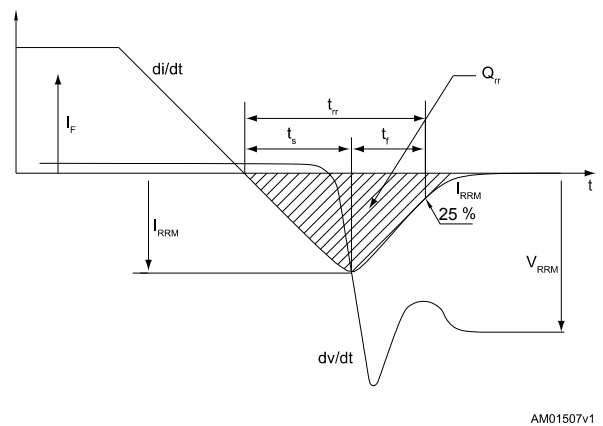

Figure 26. Thermal impedance for diode



3 Test circuits

Figure 27. Test circuit for inductive load switching

Figure 28. Gate charge test circuit

Figure 29. Switching waveform

Figure 30. Diode reverse recovery waveform

4 Package information

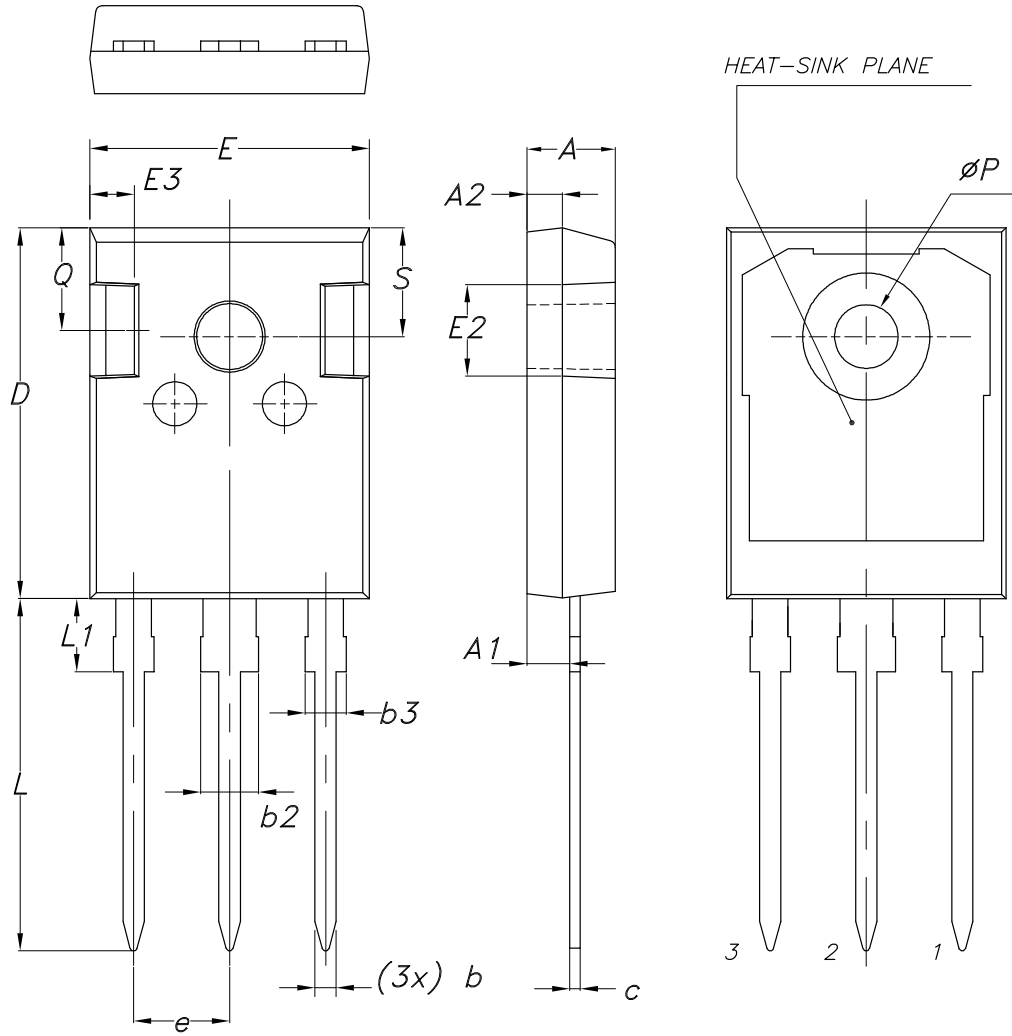
In order to meet environmental requirements, ST offers these devices in different grades of **ECOPACK** packages, depending on their level of environmental compliance. ECOPACK specifications, grade definitions and product status are available at: www.st.com. ECOPACK is an ST trademark.

4.1 TO-247 long leads package information

Figure 31. TO-247 long leads package outline



8463846_2_F

Table 7. TO-247 long leads package mechanical data

Dim.	mm		
	Min.	Typ.	Max.
A	4.90	5.00	5.10
A1	2.31	2.41	2.51
A2	1.90	2.00	2.10
b	1.16		1.26
b2			3.25
b3			2.25
c	0.59		0.66
D	20.90	21.00	21.10
E	15.70	15.80	15.90
E2	4.90	5.00	5.10
E3	2.40	2.50	2.60
e	5.34	5.44	5.54
L	19.80	19.92	20.10
L1			4.30
P	3.50	3.60	3.70
Q	5.60		6.00
S	6.05	6.15	6.25

Revision history

Table 8. Document revision history

Date	Revision	Changes
17-Nov-2016	1	First release. Part number previously included in datasheet DocID024366.
25-Jun-2019	2	Modified Table 1. Absolute maximum ratings . Minor text changes.

Contents

1	Electrical ratings	2
2	Electrical characteristics	3
2.1	Electrical characteristics (curves)	4
3	Test circuits	10
4	Package information	11
4.1	TO-247 long leads package information	11
	Revision history	14

IMPORTANT NOTICE – PLEASE READ CAREFULLY

STMicroelectronics NV and its subsidiaries (“ST”) reserve the right to make changes, corrections, enhancements, modifications, and improvements to ST products and/or to this document at any time without notice. Purchasers should obtain the latest relevant information on ST products before placing orders. ST products are sold pursuant to ST’s terms and conditions of sale in place at the time of order acknowledgement.

Purchasers are solely responsible for the choice, selection, and use of ST products and ST assumes no liability for application assistance or the design of Purchasers’ products.

No license, express or implied, to any intellectual property right is granted by ST herein.

Resale of ST products with provisions different from the information set forth herein shall void any warranty granted by ST for such product.

ST and the ST logo are trademarks of ST. For additional information about ST trademarks, please refer to www.st.com/trademarks. All other product or service names are the property of their respective owners.

Information in this document supersedes and replaces information previously supplied in any prior versions of this document.

© 2019 STMicroelectronics – All rights reserved

Mouser Electronics

Authorized Distributor

Click to View Pricing, Inventory, Delivery & Lifecycle Information:

[STMicroelectronics:](#)

[STGWA80H65DFB](#)